



USER MANUAL EN

For installation and use of leveling system
HPC312 & HPC324



HPC HYDRAULICS B.V.
Edisonstraat 18-20 7575 AT Oldenzaal
Tel: 00-31-(0)541 531303
E-mail: info@hpc-hydraulics.com



CONTENTS

General warnings and warranty provision	pag. 3
Operating procedures	
General instructions	pag. 4
Automatic operation	pag. 5
Manual operation	pag. 6
Touch Panel	pag. 7
Maintenance	pag. 11
Emergency operation	pag. 12
Troubleshoot	pag. 13

MANUAL FOR INSTALLATION HPC112 & HPC124

WARNING !

BEFORE FITTING READ THIS MANUAL CAREFULLY

DON'T WORK UNDER THE VEHICLE WHEN IT'S JUST STANDING ON IT'S HYDRAULIC JACKS. MAKE SURE THE VEHICLE CAN'T MOVE WHEN WORKING ON THE VEHICLE AND WHEN YOU USE THE LEVELING SYSTEM.

MAKE SURE NO ONE STANDS TOO CLOSE TO THE VEHICLE WHEN LEVELING

NEVER PLACE HANDS OR OTHER BODY PARTS CLOSE TO AN OILLEAK, THE PRESSURE CAN BE SO HIGH THAT IT PENETRATES YOUR SKIN

ALWAYS USE SAFETY GLASSES WHEN CONTROLLING THE SYSTEM TO PROTECT YOUR EYES FROM DIRT, METAL PARTS, OILLEAKS, ETC.

MAKE SURE ALL THE JACKS ARE COMPLETELY RETRACTED WHEN DRIVING YOUR VEHICLE, ALSO MAKE SURE THE FEET ARE SECURED LEVEL.

BELANGRIJK: INDIEN HET VOERTUIG EEN SLIDE-OUT HEEFT, LEES DAN DE PARAGRAAF VAN DE SLIDE-OUT DOOR.

IMPORTANT: WHEN THE VEHICLE HAS A SLIDE-OUT, READ THE SLIDE-OUT SECTION.

WHAT TO DO WITH WARRANTY CASES

THIS CAN'T BE INTERPRETED AS A WARRANTY STATEMENT

HPC-HYDRAULICS strives to achieve the highest possible satisfaction to its customers

Therefore, if you have a defect or a problem please proceed as follows

1e: Notify the dealer who installed the system, the dealer is fully aware of the system and can help you to solve your problems as fast as possible.

2e: If the dealer has no change to solve the problem himself please let the dealer contact us HPC-HYDRAULICS

Edisonstraat 18-20 7575 AT Oldenzaal.

Tel. +31 (0)541 222 444

Fax +31 (0)541 533 431

Make sure you give your name, the exact system that's installed on your vehicle, when it's installed and who installed the system. Please also inform us when and where we can reach you.

OPERATION PROCEDURES

GENERAL INSTRUCTIONS

Park your vehicle on firm and flat surface as is possible

Use plates or blocks on a soft surface where there is a possibility of the jacks sinking into the ground.

If the handbrake is not engaged the control panel will not start and you cannot use the leveling system.

The transmission needs to be in neutral or parking position.

Stand clear of the vehicle when using the leveling system. The vehicle can move in all directions when extending or retracting the jacks.

When the system is running, do not walk or move around inside the vehicle. This can affect the leveling system.

Press the 'STOP' button on any moment you think you need to interrupt the system.

After using the emergency (STOP) button, you need to retract all the jacks before you can start the procedure of leveling again

The system needs to be cleaned regularly, the turning points can be sprayed in with Silicone.

WARNING: do not move the vehicle until all jacks are fully retracted

PROVISIONS BEFORE DRIVING

Before driving your vehicle, visually check that all jacks are fully retracted. If this is not the case, follow the procedure for retracting the jacks.

WARNING: The driver is responsible for checking that all jacks are retracted and that the vehicle is safe to drive

If the jacks still are not fully retract and are Not in the fixed position, you need to contact your service dealer/installer.

OPERATION PROCEDURES

AUTOMATIC LEVELING and MEMORY

1. Make sure the transmission/gears are in neutral or parking position and make sure the handbrake is engaged. Stop the engine and turn the ignition key to 'accessories' position. If you haven't done the above, the control panel will not turn on.
2. Make sure the ground where the jacks are being placed is free of debris, stones, etc..
3. Press button Auto Lvl 1 the system will automatically level your vehicle. Make sure you have read the general instructions!
4. Once the vehicle is level, you can turn off the ignition, the control panel will also turn off.
5. If the angle of the vehicle is too large, it is possible the system cannot level the vehicle and will give a fault on your display (fault 12). This means the jacks are at their maximum stroke and cannot level the vehicle. Use the 'store' button to retract all the jacks. When there is a malfunction in the system it needs to be reset. Reset the system by turning off the ignition and on again. Move the vehicle to a better place so the vehicle is placed as level as possible or use filling blocks to max out the stroke of the jacks. Try the automatic leveling again. If it is still not working try the manual control.
6. When the vehicle stands level, turn off the ignition. The control panel will turn off. If you want to operate the system again, do not forget to turn the ignition on again as mentioned in point 1 above.

AUTOMATIC RETRACT

1. Make sure the control panel is turned on, if it is not make sure the ignition and handbrake are turned on.
2. Press the 'store' button, the jacks will now automatically retract.
3. Make sure all the jacks are retracted and the feet are fixed straight, so they cannot make contact with the ground when driving.
4. If this is not the case, press the 'store' button again. Check again if the jacks are fully retracted and the feet are fixed.
5. When the jacks are retracted properly, the handbrake can be taken off and it's now safe to drive.

OPERATION PROCEDURES

MANUAL CONTROL

1. Make sure the transmission/gear is in neutral or park position making sure the handbrake is engaged. Stop the engine and turn the ignition key to 'accessories' position. If you haven't done the above, the control panel will not turn on.
2. Make sure the ground where the jacks are being place are free of debris, stones, etc..
3. Press button (MANUAL)
4. To operate the system manually you need to choose a side of the vehicle, therefore you need to use the buttons: F = front, B = back, L = left and R = right
5. Choose the side you want to control, the jacks will always operate in pairs.
6. To extend or retract the jacks you need to use the buttons 'EXTEND' and 'RETRACT'.
7. It's always possible to choose a different side of the vehicle, after choosing the side you can use the 'extend' and 'retract' to operate the jacks.
8. If it's not possible to level the vehicle manually, retract all the jacks using the 'store' button. Move the vehicle to a better place so the vehicle is placed as level as possible and use filling blocks to max out the stroke of the jacks.
9. When the vehicle stands level, turn off the ignition. The control panel will turn off. If you want to operate the system again, do not forget to turn the ignition on as mentioned in point 1 above.

Panel Operating Instructions

The control panel works only when the vehicle is in contact and hand brake is operated



When the system is operating the first contact is the HPC Logo . This then switches to the Startup menu. If not in use within 5 minutes, the screen automatically returns to black, by briefly touching it will boot the screen and light up again.

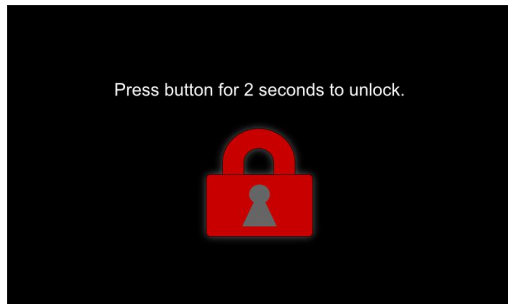

You will now have 2 seconds to press on the red lock, when the lock icon turns green you will enter the control menu.

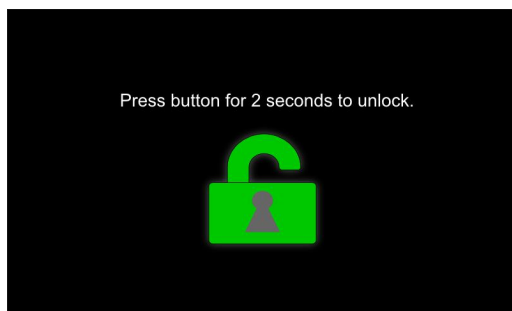

When the lock icon turns green you are automatically in the menu below, here you must accept the safety conditions to continue

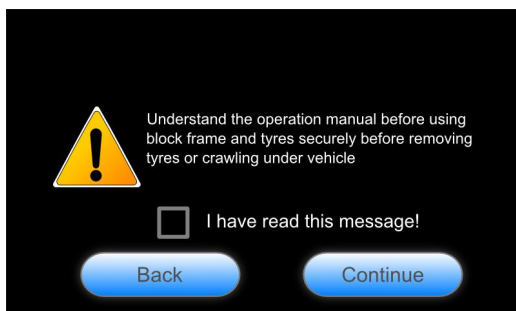

When you have read the safety warnings, tick (touch the box) to confirm you have read and press Continue to continue.

Panel Operating Instructions

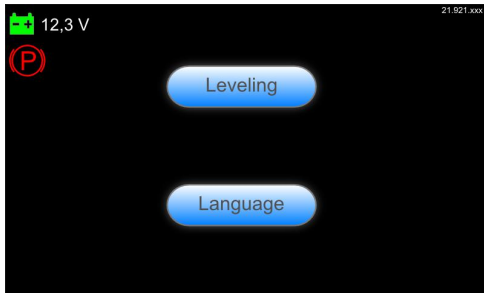

You can now change the language if it is not in the desired language, by pressing on the LANGUAGE in the menu 4 different languages are listed.

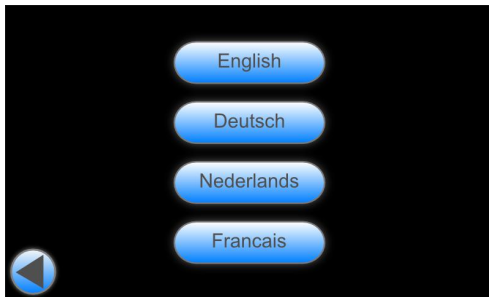

You choose a language by pressing one of the buttons, the desired Language is highlighted and activated, The arrow link in the corner, returns you to the previous menu.

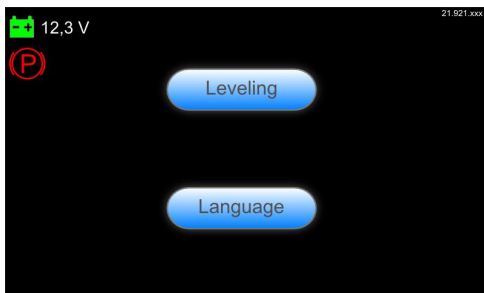

In the upper left corner of the screen is a battery indicator showing battery voltages where the system is on.
Green indicates full battery
Orange indicates battery is under 13 volt
Red indicates battery is below the 12 volt
Warning—When the voltage is too low, the system goes in failure. To resume working order charge the battery or start your engine

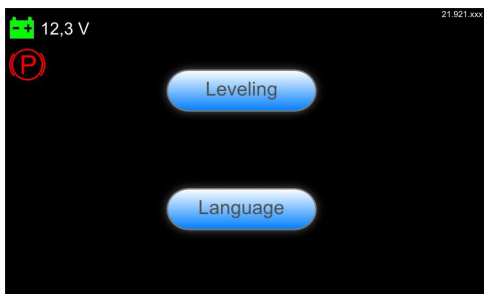

Also in the upper left corner is a Red 'P' indicating that the handbrake is on. When this is not highlighted; the handbrake is not on and the system will not work, You must have the Red P showing in the image for controlling the levelling.

Panel Operating Instructions

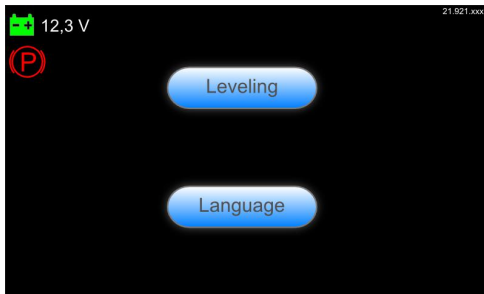

Press 'Levelling ' icon, this will move you to the next Menu where you see a series of icon buttons offering different levelling options including automatic and manual functions. Values are preset by you dealer, possibly in consultation with the end user.



The button with **Auto Lvl 1** sets the vehicle level. **Auto Lvl 2** is an end user preference mode, in which the vehicle can be set to **Tank** for emptying waste water. **Stabilize** the vehicle is only stable on flat surface

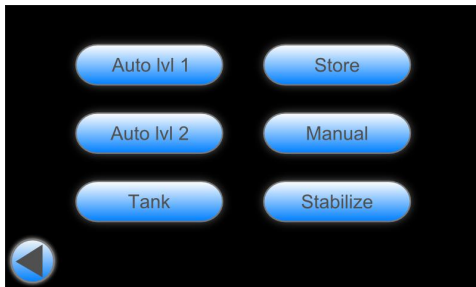

The Manual button allows you to control the levelling operation

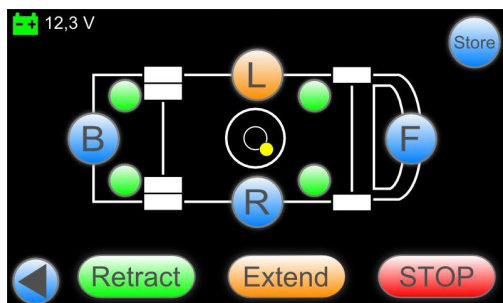

Store button will retract/recall all 4 jacks

Stop button will interrupt the program at any time and by pressing the arrow, returns you to the previous screen

The buttons F-R-B-L are blue in color. If you press L, that button turns to Orange; by pressing retract or extend, you are now controlling the the lefthand side of the vehicle. The jacks are **Green** in color as they are retracted, **Orange** if they are active, and **Blue** when the pressure is reached.

Panel Operating Instructions

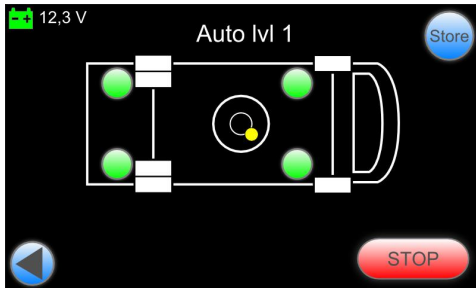

You now have Lvl 1 pressed and the vehicle display Lvl 1 screen comes up and puts your vehicle level to the preset value. When the operation is complete, it will display 'Finish' under the vehicle. After 10 seconds you will automatically return to the previous screen or you return with the arrow button

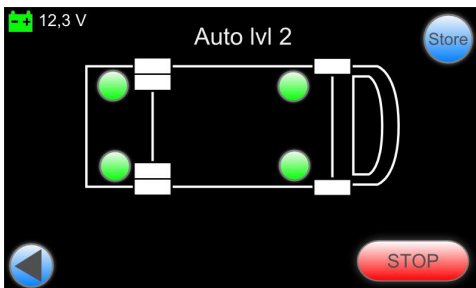

You now have Lvl 2 pressed and the vehicle display Lvl 2 screen comes up and puts you vehicle to the preset Memory value, When the operation is complete, it will display 'Finish' under the vehicle. After 10 seconds you will automatically return to the previous screen or you return with the arrow button

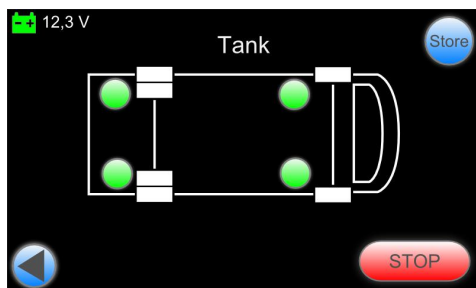

You now have on Tank pressed and the Tank screen comes sure and put your vehicle in the pre-set value, When the operation is complete, it will display 'Finish' under the vehicle. After 10 seconds you will automatically return to the previous screen or you return with the arrow button

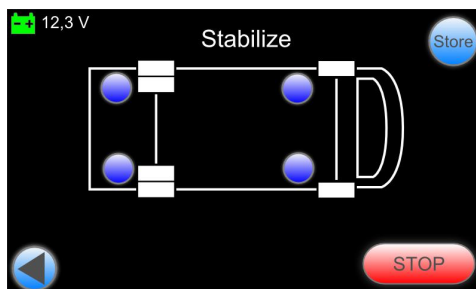

You now have on Stabilizing pressed and stabilizing screen comes up and puts you vehicle Stable this value is a fixed value and is not preset, When the operation is complete, it will display 'Finish' under the vehicle. After 10 seconds you will automatically return to the previous screen or you return with the arrow button

Store button will retract/recall all 4 jacks

Stop button will interrupt the program at any time

MAINTENANCE

OIL LEVEL

All maintenance must be done during normal inspection intervals.

The oil level should be checked periodically, and replaced every two years. When there is a leak in the system it needs to be sealed. The oil tank is located on the pump unit. The oil needs to be filled through the vent valve. Make sure that the environment is clean before unscrewing the lid and filling with oil.

The oil level needs to be 1 till 2,5 cm under the top of the oil reservoir.

Note: when the oil level is too high it can cause leakage through the vent valve.

The system uses HPC Extreme oil, When refilling the system only use the same oil, for questions please contact your dealer.

Do not use brake oil or normal hydraulic oil for jacks or lifting equipment. This will damage the system, voiding the warranty

The oil needs to be replaced every two years.

ELECTRIC SYSTEM

The car batteries must be charged and in good condition for the system to work correctly. The terminal connection should also be clean and tightened.

All electric connections must be corrosion-free and they make good contact. The ground connections need to be 100% correct for the system to work correctly.

JACKS

During installation and at least once a year the jacks cylinders need to be sprayed with waxoyl when in a retracted position!

Keep the jacks clean and occasionally spray the pivot points in with Silicone.

VISUAL INSPECTION

Periodically check the system for leaks, damage and parts such as bolts and nuts. Check the hoses for damage or splits from sharp parts making sure they are not too close to exhaust systems

Check the jacks cannot make contact with anything when they are in the retracted position. The jacks should be cleaned at least every month; the system will work better and will have a longer life time if the jacks are occasionally cleaned from dirt and mud.

OPERATING CONTROL

Check the operating instructions, only operate the system under these rules.

Retract all the jacks, make sure all the jacks are fully retracted and the feet are fixed.

TROUBLESHOOT

MANUAL-EMERGENCY OPERATION

When the system fails, for example, a fault in the system or the battery does not work, then you can **the system very simple hand operated. Note that you always have the correct procedures when you extend or retract the jacks. The procedures can be found in the chapter: Control procedures.**

1. The pump has a total of five valves (depending on the system), four are used for extend the jacks and one for retract of the hydraulic jacks.
2. Figures 1 and 3, show how the valves are standing when the system is in use.
3. If you want to use the manual . Considering of you want retract the system or extend the system. For extend the system the valve muss stay as shown in Figure 2. Would you like retract the system the valve muss stay, as shown in Figure 1
4. Now, the valve of the relevant cylinder must be turned up, so that it can be operated. On the connector to the valve indicates you can see which valve is for which cylinder.
5. If you open the valve from a cylinder you must rotate the red button.
6. Turn the entire button to the left, to open de valve (fig 5)
7. Use the lever to operate the jacks.
8. When you finish the operation, do not forget to turn the valves close again as in figures 1 and 3 will appear.
9. Always check that the jacks are fully retracted and locked!



Image 1



image 2



Image 3

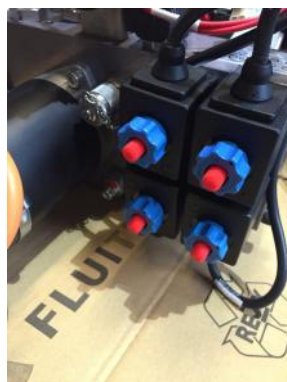

image 4



image 5

TROUBLESHOOT

THE SYSTEM DOESN'T TURN ON

The system and control panel aren't working

- Make sure the handbrake is engaged
- Is the ignition or vehicle on contact/ switched on
- Does the battery have sufficient power
- Check the wiring of the system

THE CONTROL PANEL WORKS, BUT THE JACKS DO NOT RETRACT

The jacks will not operate automatic or manually, check the following:

- Make sure the pump is running during operation, if not check the wiring
- Check the oil level
- Does the control panel give a fault (malfunction) on the display, check below what the problem is:

If there are any other problems or malfunctions please contact your dealer. If your dealer has no direct answer, let the dealer contact us and we will solve this problem together.

When you want to delete the fault and want to operate again, the system needs to be reset. This can be done by turning of the ignition (contact) off and back on again

TROUBLESHOOT

You see here under in the list failures what can light up in the screen.

Whit Failures you can contact your dealer.

Whit a "warning " the system reset self.

Whit a " Error " muss be the system reset by hand.

Over current main switch\IO module
Over current output 3\IO module (Motor relais)
Over current output 4\IO module (Return valve)
Over current output 5\IO module (Valve front left)
Over current output 6\IO module (Valve front right)
Over current output 7\IO module (Valve back left)
Over current output 8\IO module (valve back right)
Over current output 9\IO module (valve option 1 in)
Over current output 10\IO module (valve option 1 out)
Over current output 11\IO module (valve option 2 in)
Over current output 12\IO module (valve option 2 out)
Over current output 13\IO module (valve option 3 in)
Over current output 14\IO module (valve option 3 out)
Over current output 15\IO module (valve option 4 in)
Over current output 16\IO module (valve option 4 out)
Over current output 17\IO module (power for display)
Over current output 18\IO module (power for display)
Open load output 3\IO module (Motor relais)
Open load output 4\IO module (Return valve)
Open load output 5\IO module (Valve front left)
Open load output 6\IO module (Valve front right)
Open load output 7\IO module (Valve back left)
Open load output 8\IO module (valve back right)
Open load output 9\IO module (valve option 1 in)
Open load output 10\IO module (valve option 1 out)
Open load output 11\IO module (valve option 2 in)
Open load output 12\IO module (valve option 2 out)
Open load output 13\IO module (valve option 3 in)
Open load output 14\IO module (valve option 3 out)
Open load output 15\IO module (valve option 4 in)
Open load output 16\IO module (valve option 4 out)
Open load output 17\IO module (power for display)
Open load output 18\IO module (power for display)

TROUBLESHOOT

Over current Airseal output
Low power on 12Vdc system
Under voltage on 12Vdc system
Low power on 24Vdc system
Under voltage on 24Vdc system
Over voltage on 12Vdc system
Over voltage on 24Vdc system
Output "Proximity" overcurrent
Output "cabine" overcurrent
Output "switch" overcurrent
Sensor orientation started
motor shut down on maximum pressure
angle of the vehicle is too big to start auto functions
no signal from pressure sensor
wrong signal from pressure sensor
auto level not completed.

Pressure sensor lost
Pressure sensor lost, autolevel functions are not allowed.
CAN bus not running
Continue at own risk!
Vehicle is out of range. put vehicle on waterlevel surface
Waterlevel sensor is lost can't use automatic functions
Time out on airseal vacuum.
It takes too long to read out the history
Error on the IO module.
Warning on the IO module.
Time out on autolevel function.
Error on the autolevel function

Dealers information

When the user goes to another dealer than the dealer who has built the set, we would like that the dealer indicating perform the installation where certain cables connected so that the search for these cables is easier

Connecting the 16 square power cable:

Board Battery

Starter battery

Instead of the 125 AMP fuse holder

place.....

Connecting the ACC power cable

place.....

Positioning the Pump

place.....

Name Dealer

date of incorporation